

Soft Magnetic Composite Application Examples

Single Sided Axial Flux Machines

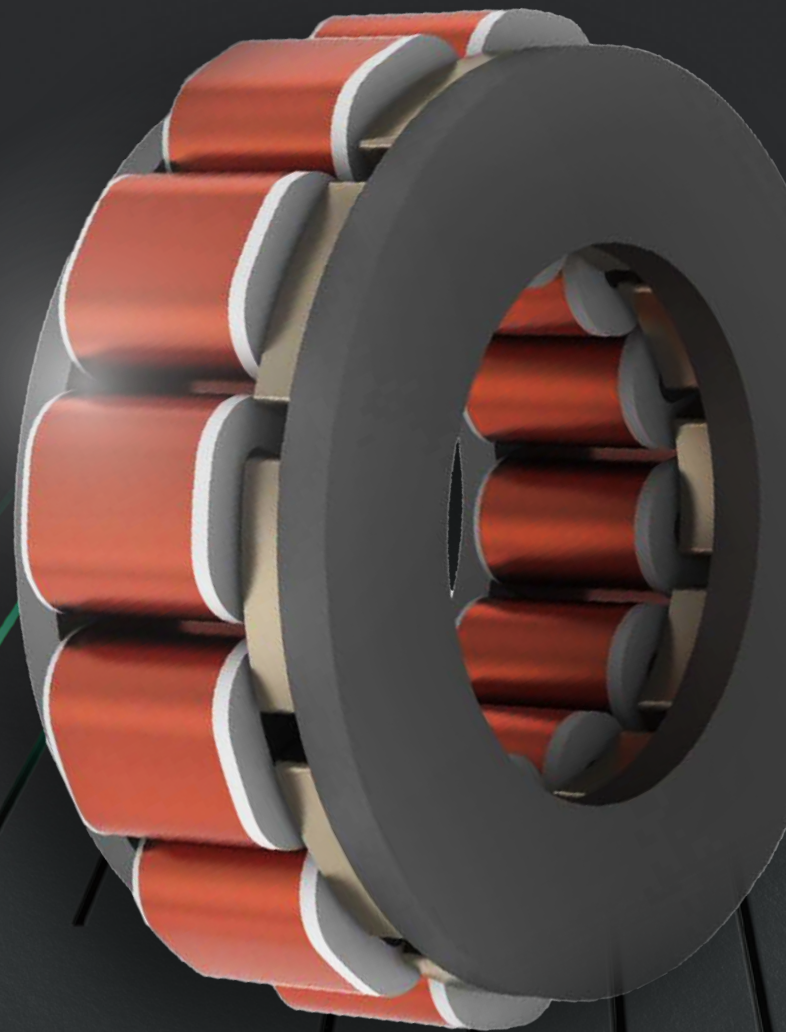

February 2024

ABSTRACT /

The past decade has seen significant development in the field of soft magnetic composite (SMC) materials and their application in electrical machines. A large part of this can be attributed to their isotropic magnetic properties, allowing for relatively complex structures to support magnetic flux whilst suppressing losses. Furthermore, the material isotropy benefits the thermal performance, allowing heat to dissipate in all directions

In order to take full advantage of SMC technology in electric motor applications, it is necessary to address the design, material and processing aspects. Radial flux motors are well suited to the axial symmetry that is fulfilled by laminated stacks of electrical steel sheets. Axial flux motors, however, are tricky to manufacture with this approach and provide a good design example for the SMC technology. The stator and rotor manufacturing benefits from the

well-established powder metallurgical (PM) compaction process, a single operation that provides a final high density, net-shaped product. Subsequent heat-treatment relaxes the domains of the material and provides mechanical strength and a low loss characteristic.

This document presents a short overview of the SMC technology, from process to powder properties, together with a concept application study. The motor concept is an open-slot, single-sided axial flux machine (SSAFM) with 12 slots and 10 poles, designed to achieve a nominal specification. This concept has been modelled and simulated using JMAG, applying materials that are readily available in the JMAG material database. Details of the electromagnetic design process, model set-up and results are presented.

CONTENTS /

1. INTRODUCTION /	4
1.1. Process overview	5
1.2. Material overview	5
2. SINGLE-SIDED AXIAL FLUX MACHINE OVERVIEW /	7
3. DESIGN OUTLINE /	8
3.1. Geometry Definition	8
4. MODEL SIMULATION SETUP AND RESULTS /	10
4.1. JMAG Model Settings	10
4.2. Simulation Results	13
5. CONCLUSION /	15

1. INTRODUCTION /

Soft Magnetic Composite (SMC) components are produced by the well-established powder metallurgy process, where compaction of powdered iron can yield high density, net shaped components. Through a reduction in manufacturing yield losses and post-production operations, it is an efficient and cost-effective process. Furthermore, lower energy consumption by comparison to other production technologies can be realised. The SMC materials are suitable for large-scale mass production of components with accurate tolerances, smooth surfaces, no secondary operations and minimal material waste.

The primary characteristic of the SMC materials is its ability to allow the magnetic flux to flow in three dimensions: the individually inorganically coated iron particles create a magnetically and thermally isotropic path which can provide benefits through the inherent freedoms of design. Moreover, the iron particles can be sized for specific applications, allowing the suppression of iron losses as frequency increases: as the particle size reduces, the surface area for the coating provides a greater bulk resistivity, in the region of tens of thousands of micro-Ohm metres, significantly reducing eddy current losses. Relating the forming of an SMC component to a stack of punched lamination steel sheets underlines the advantages for the SMC process. SMC is formed to a net-shape in a single operation, achievable at speeds of up to 20 components per minute, depending on the size, required density and geometric complexity of the component. The SMC component is a single part, where almost all the powder from the filling shoe forms the component. This can be compared to punched lamination sheets, where a large amount of scrap material is generated, and the individual laminate sheets must be carefully

handled, stacked and bonded to form a final assembly in a secondary process. Furthermore, the SMC component can be designed with chamfer or rounded edges in a plane perpendicular to the magnetic flux vector. This may improve the form factor for the coil winding and reduce its weight, saving on high-cost parts. The intrinsic material properties lead to differences in magnetic, thermal and mechanical properties. Therefore, simply replacing the existing laminated iron core in an electrical machine with an SMC material will typically result in a loss of performance with very small compensating benefits. A lower relative permeability results from coating individual grains, and the use of high purity iron yields higher hysteresis losses: the dominant loss mechanism at low frequencies, particularly when compared to laminated steel. To overcome this, and to take full advantage of the SMC material, it is recommended to design the electromagnetic components with consideration paid to the unique property profile, moving to a higher pole number to increase frequency, for example.

The concept presented here is a single-sided axial flux machine (SSAFM). It is a surface mounted permanent magnet motor with a modular construction concept. The fabrication of the SMC parts greatly benefits from this modular approach, where compaction of a relatively simple stator component and rotor coreback - in single respective press operations - allows coils, with associated insulation, wound off-part, and magnets to be applied prior to assembly. High strength NdFeB magnets are used to provide a strong magnet MMF whilst the pole number is chosen to deliver a compact solution, driving the frequency of operation higher and into a region of comparatively lower loss. The slot-pole combination is selected to provide low ripple characteristics for an open slot stator.

1. INTRODUCTION /

1.1. Process overview

The powder process involves the creation of a base powder mix, which includes all the necessary elements for producing a robust SMC component, compaction and, finally, heat-treatment.

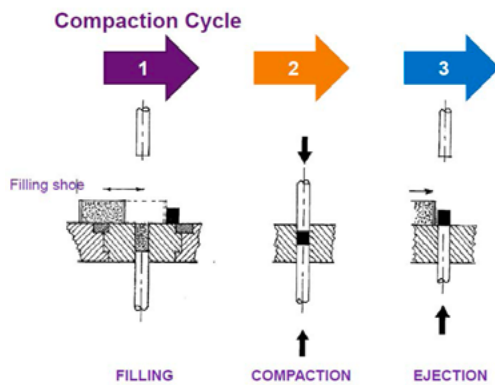

Figure 1. The PM Powder Metallurgy forming process in three steps

The compaction process is depicted in Figure 1, where powder is fed into a die tool cavity before being compacted under high pressure to form the final net-shape component. This is then ejected from the tool and transferred to the heat-treatment. Heat-treatment is conducted under a strictly controlled temperature profile to evaporate compaction lubricants, relax grain boundaries and harden the structure. The furnace can have a specific environment, where gases present in the atmosphere improve the component performance.

The component density is related to the actual pressure of compaction. The higher the component density the more magnetically active material is present. The performance of the material, in terms of loss, at a given frequency is determined by the size of the particles in the initial mix; for lower frequency applications, large particle sizes are best suited.

Conversely, high frequency applications will benefit from smaller particle sizes, with an overall larger surface area available for coating. The properties and performance of the SMC material depends upon the powder mixes, discussed below.

1.2. Material overview

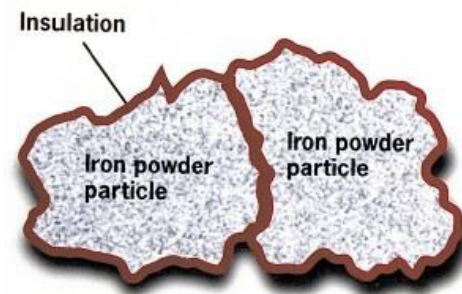

Figure 2. SMC powder particle with electrically resistive coating.

SMC materials, are made of high purity iron powders with nanometre-size inorganic surface insulation, as shown in Figure 2. The iron powders are available in several grades with particle sizes of between 50 – 250 micrometres. The resultant performance of the powders is highly dependent on this coating and its sensitivity to the compaction and heat-treatment processes. The additives - such as lubricants for powder filling and ejection from the die tool post compaction, for example - and the heat-treatment process, must be optimal to yield the desired performance from the component.

1. INTRODUCTION /

During the compaction phase, there is a physical limit on the pressure that should be applied to the powder in the die tool, which is determined by the pressing force and the part geometry. Under compaction forces that exceed the material limits, the coating will breakdown and the resultant component will not have the electromagnetic properties expected. Where heat-treatment is concerned, the maximum permissible temperature is important for fully stress relieving the grain boundaries after compaction has taken place. This will reduce hysteresis loss and improve permeability, through the removal of impurities, such as lubricants, for example. Exceeding this temperature will breakdown the coating and reduce the electromagnetic performance, along with introducing mechanical defects into the component.

2. SINGLE-SIDED AXIAL FLUX MACHINE OVERVIEW /

Both radial and axial flux machines share a similar electromagnetic arrangement, where magnet flux travels in the denoted direction: the two motor configurations are shown in Figure 3. It is clear that the flux path for a radial motor travels in a two-dimensional plane that can easily be repeated in the axial direction to form a laminated stack. For axial motors to utilise laminations, a complex index punching technique to create a spiral wound stack or the implementation of careful machining on a formed laminated ring would be required, creating a significant challenge for mass manufacture. SMC, therefore, becomes an ideal fit for motor topologies such as the axial flux machine, where the material's isotropic magnetic properties allow magnetic flux to flow in three dimensions whilst losses are suppressed in relation to the powder grain sizing.

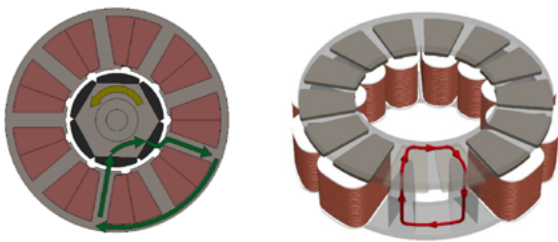

Figure 3: Flux path in traditional Radial Flux Machine (RFM) and Axial Flux Machine (AFM)

The construction of an axial flux machine can be seen in Figure 4. Due to the nature of the compaction process, the stator features an open slot design. This allows coils to be wound separately onto bobbins and slotted onto the stator teeth. Additional tooth tips can be attached to the teeth in order to concentrate the flux and increase torque performance whilst further reducing cogging. However, this increases complexity and adds cost to the design with marginal benefits.

Magnets are glued onto the rotor disk. The rotor disk is made from SMC to suppress the induced eddy-current losses arising from airgap harmonics.

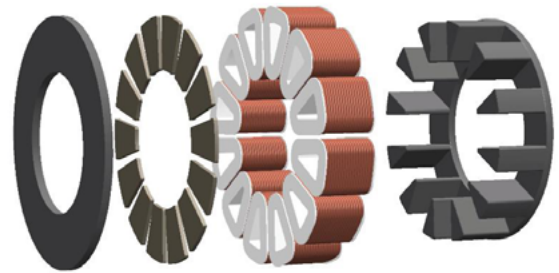

Figure 4. Single-Sided Axial Flux Machine components

The benefits of the SSAFM concept are:

- // Compact size, reduced weight of the components and assembly
- // High specific performance
- // Cost-efficiency due to the compact design and simple net shaping production process with minimum waste and reduced need for subsequent operations

3. DESIGN OUTLINE /

This section describes the design approach for a SSAFM to fulfil a nominal specification. The stator SMC component is restricted to 100 mm outer diameter (OD) and the DC voltage fully available at the motor terminals is restricted to 350 V. The specification is displayed in Table 1. Since the machine is forced air cooled, the assumed continuous current density is restricted to a conservative 5 ARMS/mm², where a short-term overload must also be achieved.

Parameter	Value	Unit
Peak power	4900	W
Overload torque	7.8	Nm
Nominal torque	3.1	Nm
Efficiency	92	%
Nominal speed	6000	rpm
Maximum speed	6000	rpm
DC voltage	350	V
Maximum OD (stator)	100	mm
Thermal management	Forced Air	-

Table 1. Design Specifications

3.1. Geometry Definition

The suggested geometry for the design can be seen in Table 2, with key geometric parameters depicted in Figure 5. The stator component OD is 100 mm, however the additional winding width increases the total OD to 109.7 mm, with a total axial length of 40.5 mm. The magnet material is NdFeB, grade N45SH. The airgap is set to 1 mm, a clearance that can easily be achieved with regular production tolerances. The distance from the top turn of the coil to the airgap is set to minimise the effects of the parasitic AC copper losses.

The slot-pole combination, 12 stator teeth and 10 rotor poles, is well suited to an open-slot concentrated winding motor. The cogging torque is determined by the lowest common multiple of the slot-pole, where a greater number yields a higher frequency. For one mechanical revolution, 60 cogging pulses will be observed. The high pole number is desirable as it reduces the size of several components, giving a better torque density with regard to both mass and volume. Without a high pole number, the balance of iron and copper loss will be affected with the majority of the torque produced by applying a large current, resulting in a high copper loss.

Parameter	Value	Unit
Tooth Number	12	-
Pole Number	10	-
ID min (with coil)	50.3	mm
OD max (with coil)	109.7	mm
Axial Length	40.5	mm
Coil Width	4.5	mm
Turn Number (per coil)	100	-
Tooth Axial Length	24	mm
Stator Radial Height	20	mm
Stator Coreback Depth	5	mm
Airgap Thickness	1	mm
Rotor Coreback Depth	6	mm
Magnet Depth	4.5	mm
Magnet Span	150	deg
Insulation Thickness	0.75	mm
Total Distance Coil from Airgap	2	mm
Stator Material	Somaloy 700HR 5P	-
Rotor Coreback Material	Somaloy 700HR 1P	-
Winding Material	Copper	-
Magnet Material	N45SH	-

Table 2. Geometrical parameters of the proposed machine

SINGLE SIDED AXIAL FLUX MACHINES

FIGURE 5. ILLUSTRATION OF THE MAJOR MACHINE DIMENSIONS OF A SINGLE COMPONENT AXIAL FIELD MACHINE /

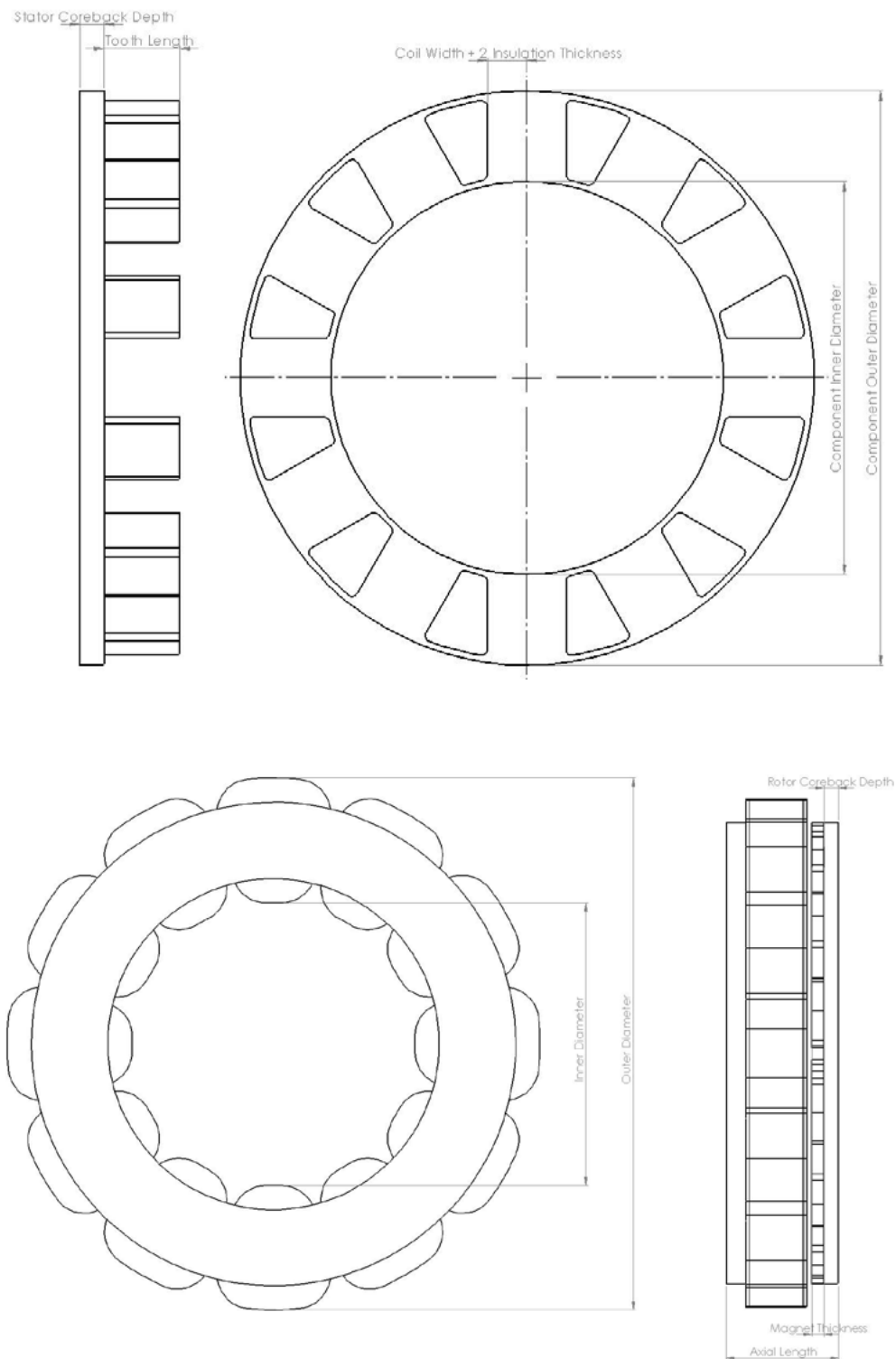

4. MODEL SIMULATION SETUP AND RESULTS /

4.1. JMAG Model Settings

Materials

The soft magnetic composite materials manufactured by Höganas AB are contained in the JMAG material database. For this model, 700HR 1P material is used in the rotor to suppress the eddy currents from the stator field. The stator uses a more advanced material, 700HR 5P, which has a lower specific loss, necessary for a component with a varying field throughout. High grade NdFeB magnets are used to provide a large magnet MMF, an important factor with a relatively low permeability material and large effective airgap: no correction is made for any magnet insulation setting applied, and 100% of the volume is assumed to be active material.

Temperatures are set based on steady-state operating criteria: this will weaken the magnet MMF and increase the coil resistance (set manually from a coil path length and temperature dependent resistivity). Eddy currents are set to be allowed to flow in the stator teeth and coreback, rotor coreback and magnets. The material settings are contained in Table 3.

Component	Material	Grade	Temperature (°C)	Eddy Currents
Stator Teeth	SMC	Somaloy® 700HR 5P	-	Yes
Coil Insulation	Plastic	-	-	No
Coil Winding	Copper	103% IACS	120	No
Rotor Coreback	SMC	Somaloy® 700HR 1P	-	Yes
Magnets	NdFeB	N45SH	100	Yes

Table 3: Material Settings

Coils

The phases should be configured as three separate FEM Coil conditions with each condition containing four coils, Group 1 to 4 in Table 4. For a 12 slot motor with 10 poles, the coils are counter-wound in adjacent pairs that are connected in series, each pair can then be connected either in series or parallel. Viewed in the XY plane, the coil directions can be set as clockwise (C) or anticlockwise (AC), see Figure 6 for reference.

	Phase A	Phase B	Phase C
Group 1	Coil 1 (AC)	Coil 3 (C)	Coil 5 (AC)
Group 2	Coil 2 (C)	Coil 4 (AC)	Coil 6 (C)
Group 3	Coil 7 (C)	Coil 9 (AC)	Coil 11 (C)
Group 4	Coil 8 (AC)	Coil 10 (C)	Coil 12 (AC)

Table 4: Coil Arrangement

4. MODEL SIMULATION SETUP AND RESULTS /

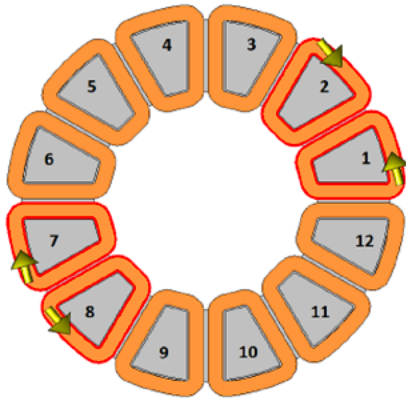

Phase 1

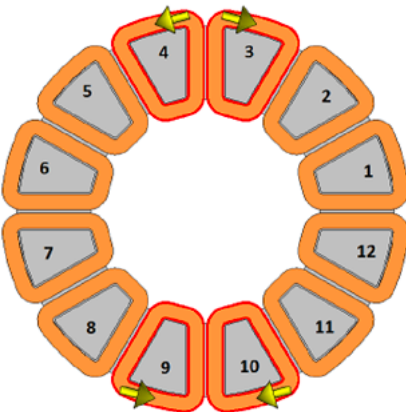

Phase 2

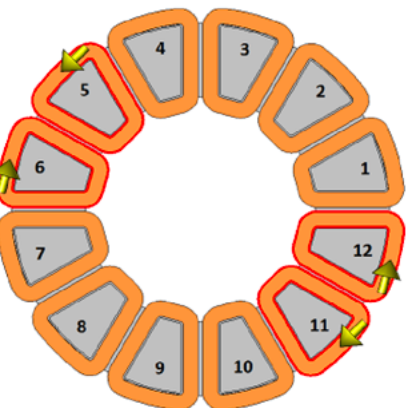

Phase 3

Figure 6 Winding layout for a 12-10 axial flux machine.

The coil is made up of 100 turns of 0.9 mm diameter bare copper wire. With grade 2 insulation, the overall diameter is 0.989 mm at maximum tolerances. Each turn is a single strand of wire. A possible coil turn layout for the machine is shown in Figure 7, this should be confirmed with a specialist coil winding company, particularly as turn number increases and the margin for error becomes smaller. Each phase is made up of all 4 coils connected in series. The temperature is set to 120 °C and the resistance of each phase can be calculated to 1.076 Ω.

Motion

The motion region is set using the Rotation Motion condition applied to the rotor coreback and magnet segments. The speed is set as a constant revolution speed (6000 rpm). An initial position is applied with a step-back of 4 degrees mechanical (-4°) to remove the initial transient, this must be reflected in the electrical phase for maximum torque per amp. Nodal Torque and Nodal Force conditions are applied to the rotor component with the motion region, the latter allowing Z-component forces to be obtained for bearing calculations.

Iron Loss

The Iron Loss condition is set for both the Stator Teeth (including the coreback) and the Rotor Coreback components. The calculation method uses Preset 1, which utilises the Apply Loop method and FFT to calculate the hysteresis and in-particle Joule loss, respectively. The bulk eddy loss is the remnant from subtracting the Iron Loss condition

4. MODEL SIMULATION SETUP AND RESULTS /

values from the total loss density calculated in the field analysis.

The pole number (10) is set and the angular velocity (6000 rpm) is the same as the motion component. No periodicity is included in this example model.

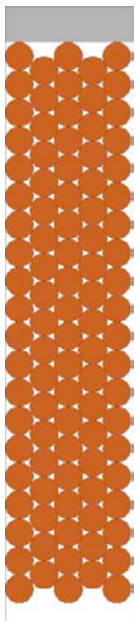

Insulation

The Insulation modelling condition is set due to magnets being split. In the same way laminating a stator core reduces eddy current path lengths, splitting the magnet will help to reduce the Joule loss, important in surface mount permanent magnet motors. The condition applies a perfect insulation surface, which would impact the magnet material content in real terms: this can be adjusted in the material's Magnetic Properties Correction if required.

Figure 7: Coi lturn layout

Circuit

The circuit comprises a three-phase sinusoidal current source with the amplitude set based on the coil current density, frequency defined by the speed and pole number, and phase, dependent on the connection method and mechanical rotor angle. Three FEM coils are set, linked to their conditions in the simulation environment, with turn number and resistance specified: the values are provided in Table 5. No leakage inductance is applied. Voltage probes are applied, and terminals added at the nodes to enable the voltage difference to be observed

for a delta connection. Figure 8 shows the circuit layout in JMAG.

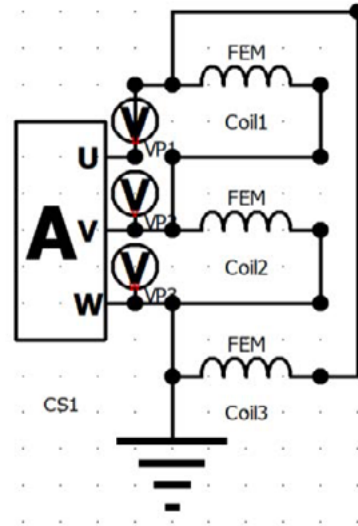

Figure 8: Circuit configuration in JMAG

Parameter	Value	Unit
Current Amplitude	7.792	A _{pk}
Frequency	500	Hz
Phase	-110	°
Coil Turns	100	-
Constant Resistance	1.076	Ω

Table 5: Circuit values

Mesh

Meshing is controlled on parts to provide a robust but time efficient solution, solving a full model in approximately 20 minutes. A slide mesh is used with a semi auto mesh generation method and automatic subdivisions applied. For JMAG v18.0 onward, the extended slide plane is set in the properties menu, here with 120 circumferential divisions. This mesh is not suitable for establishing ripple or cogging torque. Coil1 mesh can be set to be much finer without im-

4. MODEL SIMULATION SETUP AND RESULTS /

packing greatly on the solve time. This allows the flux density in the region to be probed and an analytical approximation of AC loss to be formed. There are better methods to find the AC loss in this motor type and will be discussed in separate documentation. Mesh parameter values are shown in Table 6, with the resultant model mesh depicted in Figure 9.

Mesh Name	Parts/Faces	Element Size (mm)	Properties	Value
Stator	Stator Teeth and Insulation	2	Mesh Type	Slide Mesh
Rotor Coreback	Rotor Coreback	2	Generation method	Semi Auto
Magnets	Magnet1 to 10	1.5	Air Region Radial	1.5
Airgap Faces	Stator Teeth and Magnet Faces	1	Air Region Axial	3
Coil 1	Coil1	3	Element Size of Parts	10
Coil 2 - 12	Coil2 to 12	3	Circumferential Divisions	120

Table 6: Mesh Properties



Figure 9: Mesh of SSAFM model

4.2. Simulation Results

Rated conditions of 3.1 Nm of torque at 6000 rpm, shown in Figure 10, is reached with a 5 ARMS/mm² current density, which is a comfortable thermal load for a motor with this type of cooling. Peak line-line voltage is 312.87 V, depicted in Figure 11, which is lower than the specified 350 V, however, there must be some headroom in order to achieve the overload point.

The electromagnetic efficiency at rated conditions is 93.46% (AC skin & proximity losses are not included in the analysis which may reduce the efficiency slightly). Given the small conductor cross section area this is likely to not be a substantial factor.

A short-term overload condition, shown alongside the rated condition in Figure 10, of 7.8 Nm can be met with a 13 ARMS/mm² current density and the electromagnetic efficiency is 93.37%. The on-load voltage depicted in Figure 12 exhibits some armature reaction as the airgap field becomes less sinusoidal. The simulation results are summarised in Table 7.

Parameter	Rated	Overload	Unit
Speed	6000	6000	rpm
Frequency	500	500	Hz
Line current	7.79	20.26	A _{pk}
Current density	5.00	13.00	A _{RMS} /mm ²
Average torque	3.19	7.86	Nm
Average torque (compensated)	3.13	7.80	Nm
Torque ripple at rated current	10.57	5.20	%
On-Load Voltage	312.87	358.40	V _{LI-pk}
Magnet losses	43.09	50.14	W
Total iron losses	60.18	73.99	W
Three-phase coil losses at 120 °C	34.45	223.47	W
Motor losses	137.73	347.60	W
Mechanical shaft power	1969.50	4899.06	W
Motor efficiency	93.46	93.37	%

Table 7. Simulation results for the machine.

4. MODEL SIMULATION SETUP AND RESULTS /

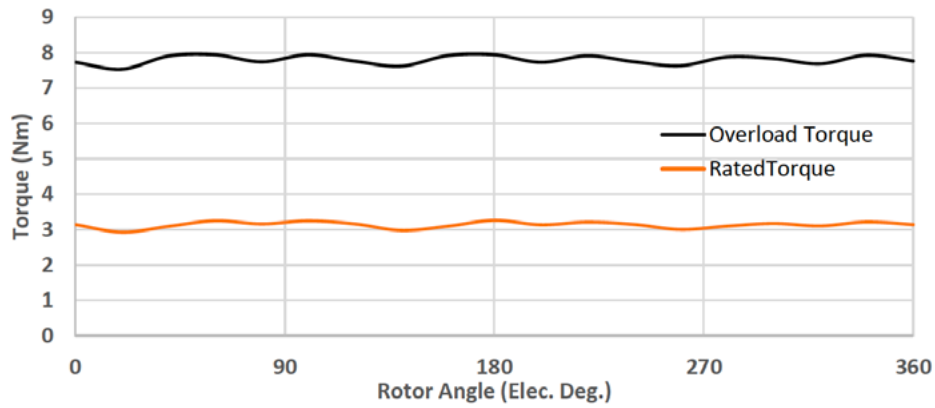

Figure 10. Torque waveform at 5.51 ARMS and 6000 rpm

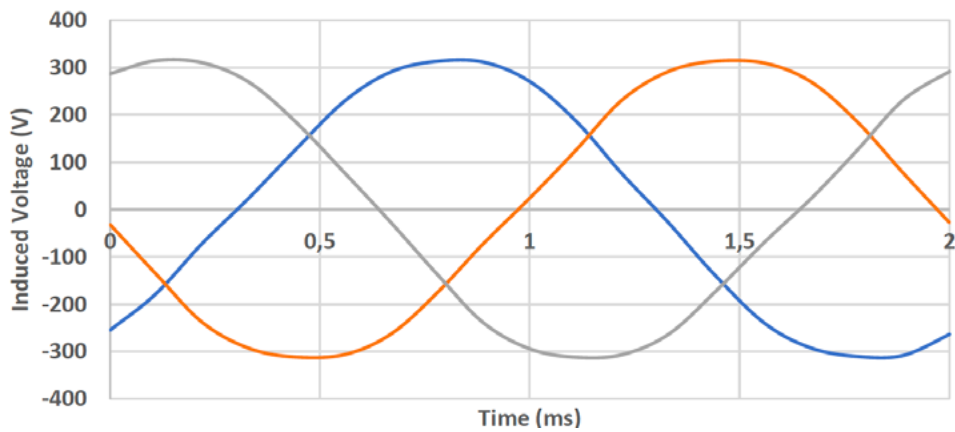

Figure 11. Line to Line On-Load Voltage waveform at 5.51 A and 6000 rpm

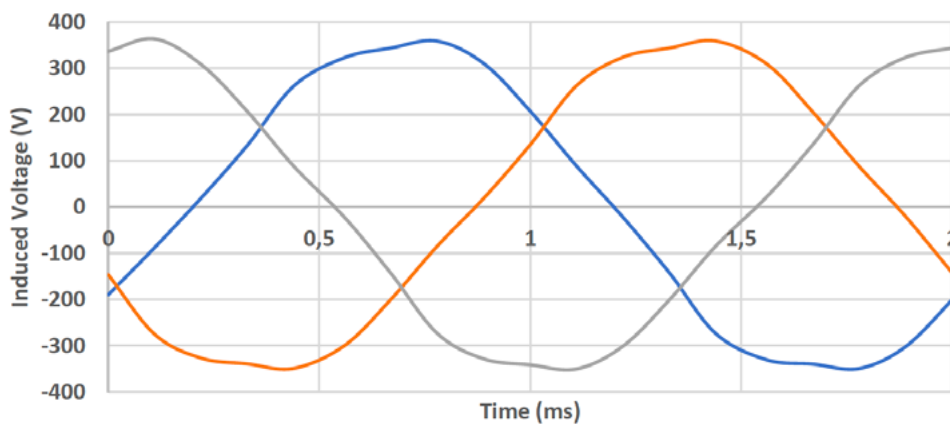

Figure 12. Line to Line On-Load Voltage waveform at 14.32 ARMS and 6000 rpm

5. CONCLUSION /

An axial flux machine design has been shown as an example of the potential benefits for utilising SMC in electric motors. The isotropic nature allows for three-dimensional magnetic flux distribution within the component. For axial flux motors, this is advantageous, where axial and circumferential flux paths exist. Additionally, the ability to control the size and insulation of the iron particles make SMC advantageous, opening the possibilities for applications that have high operating frequencies through an increase in pole number, speed or both. The use of the powder metallurgy process allows for minimal waste during production. Moreover, a variety of geometrical features can be integrated into the SMC die tool, serving functionalities like enhanced mounting features and rounded surfaces for minimising end-winding regions.

Basic design considerations for a SSAFM were presented in the report. The designed machine utilises high strength NdFeB magnets to achieve an overload power of 4.9 kW. The outer diameter is 109.7 mm and the axial length is 40.5 mm, making for a compact design. All operating points are achieved within the specification and efficiencies of over 93% are achieved. Further aspects to consider in the design of a SSAFM with open slots and surface mounted magnets are the AC loss - skin and proximity effects - magnet Joule loss mitigation with active material reduction through insulation, and demagnetisation. These will help to inform any thermal characterisation and provide a more in-depth picture of the motor performance achievable in its operational environment.